



severn valley
woodworks

Timber Boarding

total timber solutions - www.svw2000.co.uk



*Timber boarding products from **Severn Valley Woodworks** provide so many design options for use within building and outdoor projects.*

All profiles are machined and manufactured by ourselves from high quality kiln dried softwoods and are available in various lengths from 3m to 6m.



Our boarding timbers can be supplied either untreated or preservative pre-treated with TANALITH® E wood preservative to help ensure an extended and low maintenance service life.



Our standard range of designs is detailed on the following pages. However, we can also manufacture specific requirements to order.



PRESSURE TREATED TIMBER

BOARDING - T&G



severn valley
woodworks

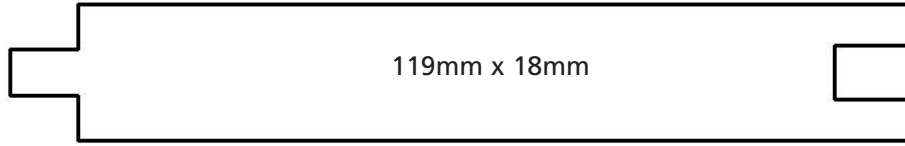

119mm x 18mm

No. 401

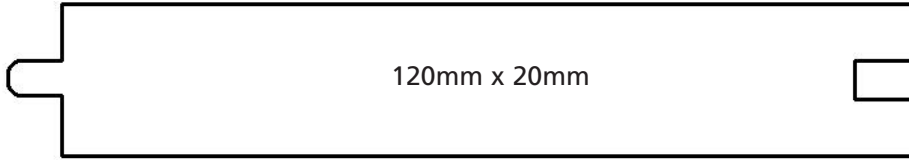

120mm x 20mm

No. 402

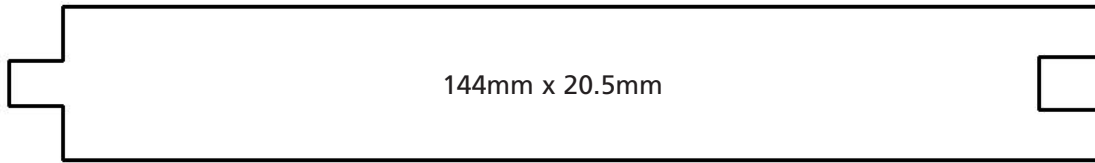

144mm x 20.5mm

No. 403

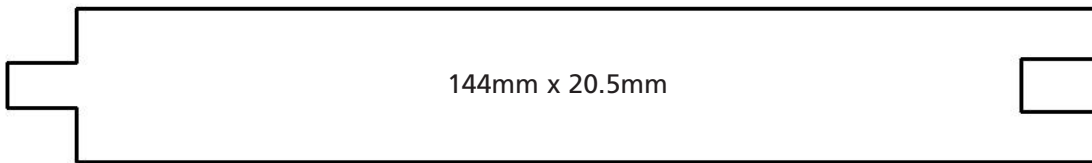

144mm x 20.5mm

No. 404

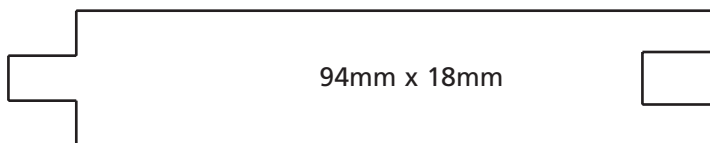

94mm x 18mm

No. 405

total timber solutions - www.svw2000.co.uk



severn valley
woodworks

total timber solutions - www.svw2000.co.uk

BOARDING - TGV

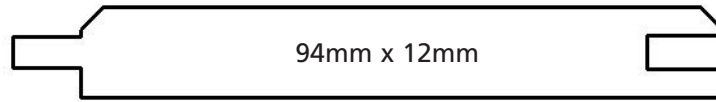

No. 501

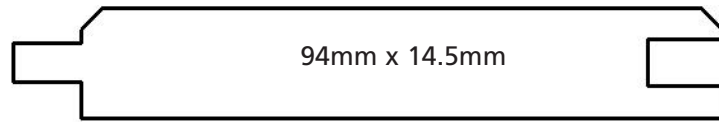

No. 502

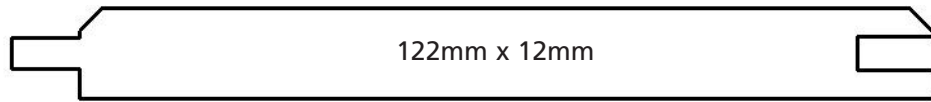

No. 503

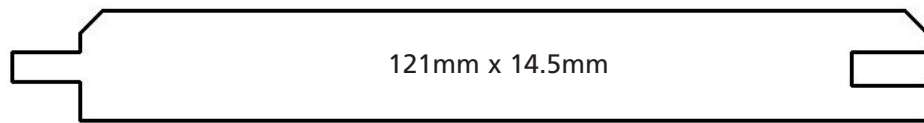

No. 504



No. 505

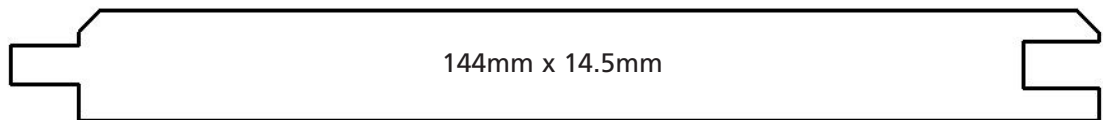

No. 506

BOARDING - TGV



severn valley
woodworks

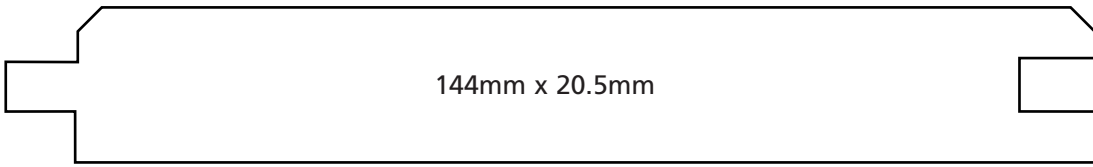

144mm x 20.5mm

No. 507

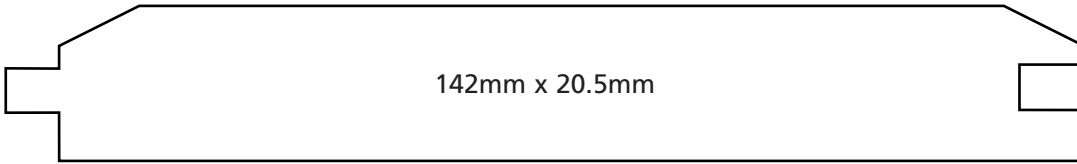

142mm x 20.5mm

No. 508

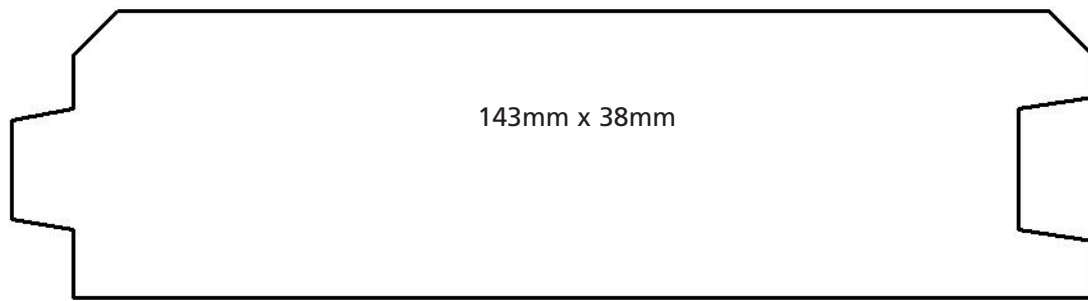

143mm x 38mm

No. 509

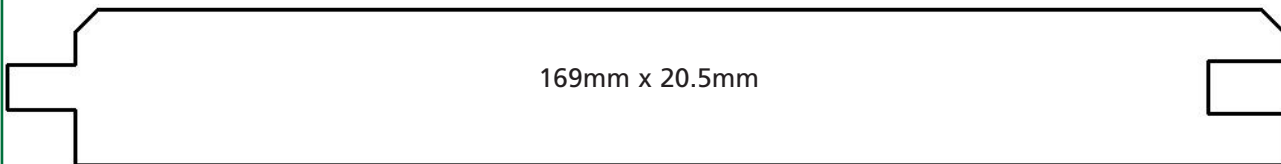

169mm x 20.5mm

No. 510

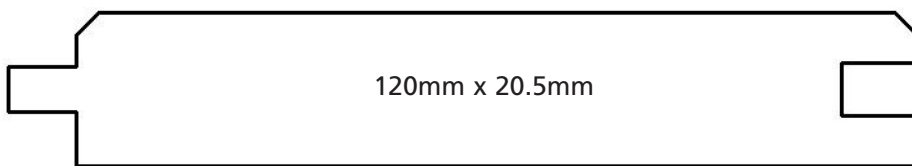

120mm x 20.5mm

No. 511

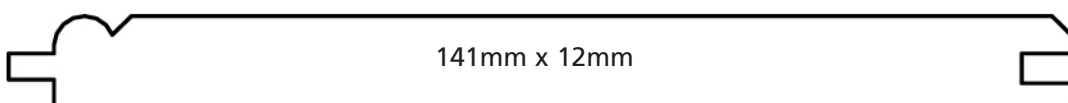

141mm x 12mm

No. 512

total timber solutions - www.svw2000.co.uk



severn valley
woodworks

total timber solutions - www.svw2000.co.uk

BOARDING - TGV

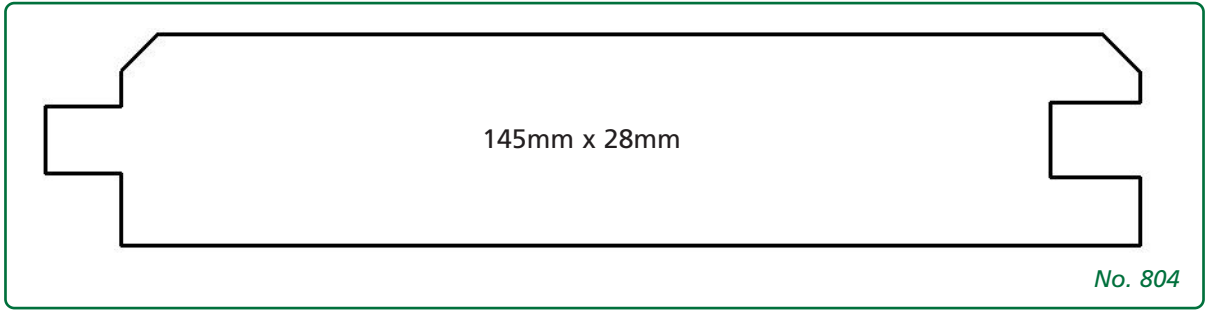

BOARDING - TG2V

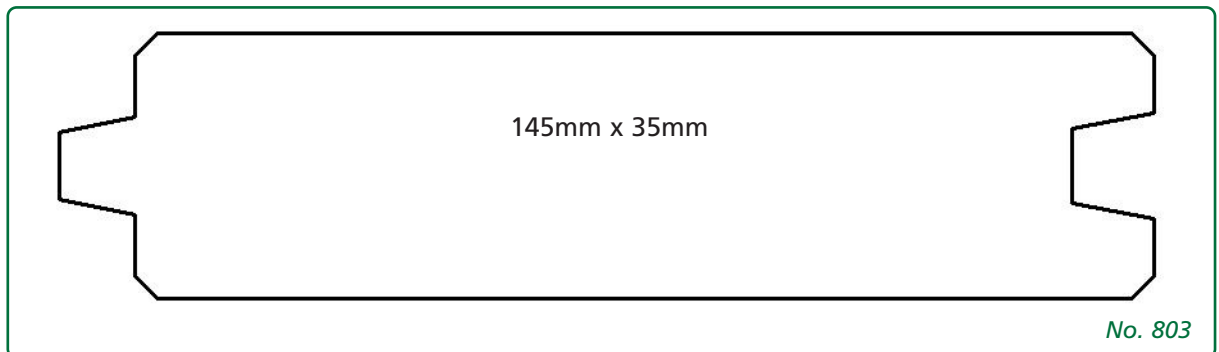
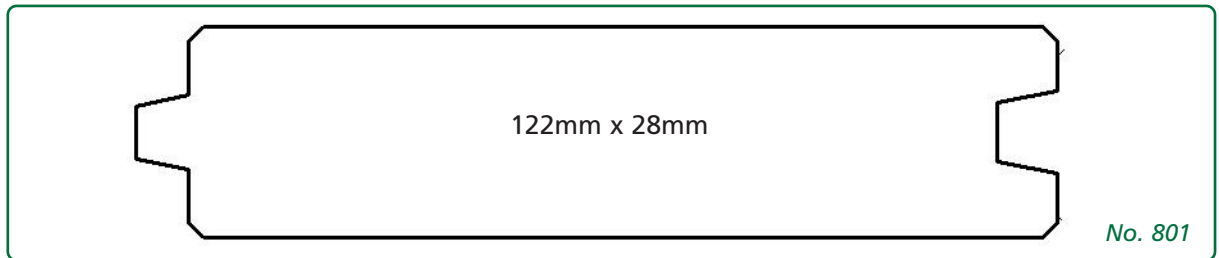
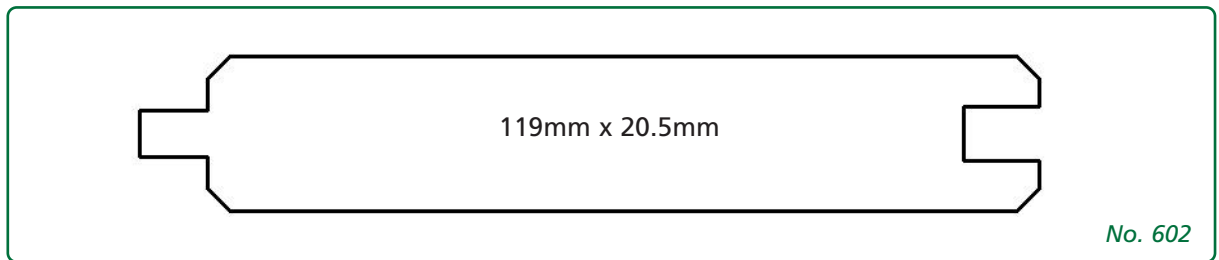
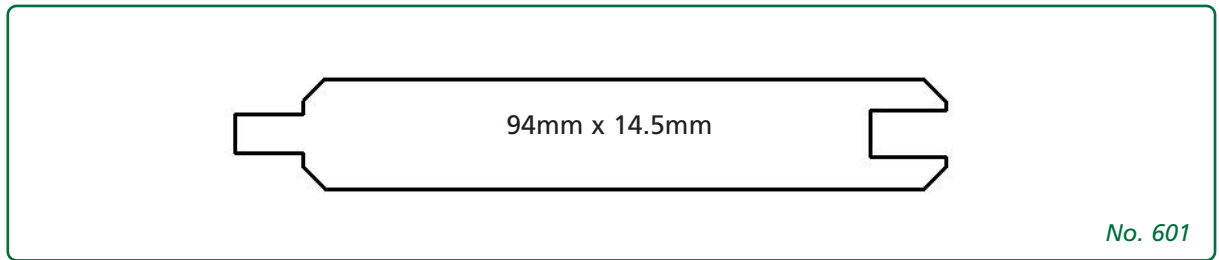

BOARDING - TG2V



severn valley
woodworks

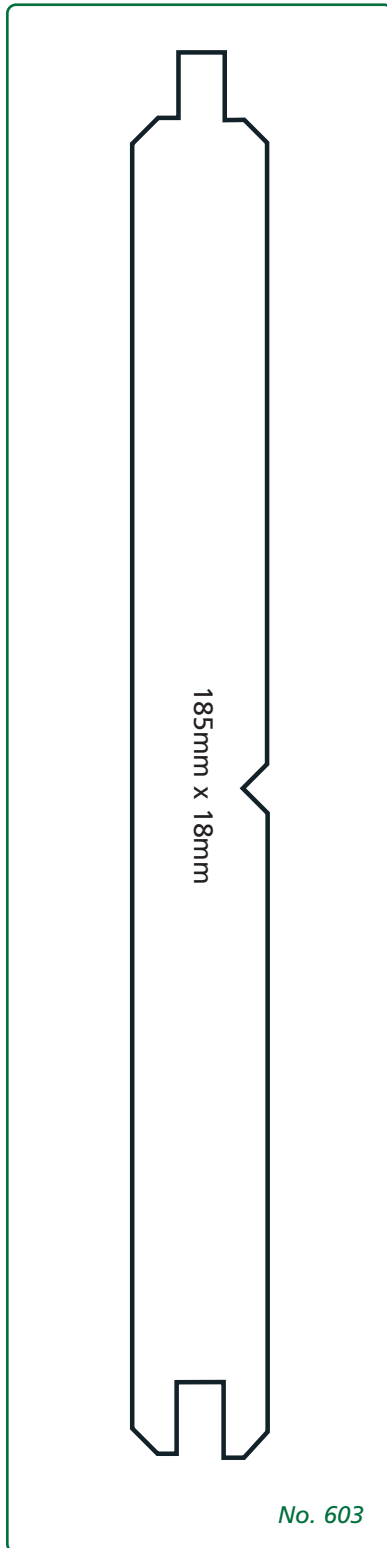

total timber solutions - www.svw2000.co.uk